



Operation UNIFIED RESPONSE

Mission Update Brief

Operation Unified Response

31 January 2010

Overall Classification of this briefing is **UNCLASSIFIED**



Task Organization

In support of the Government of Haiti ICW the United Nations
Operation UNIFIED RESPONSE

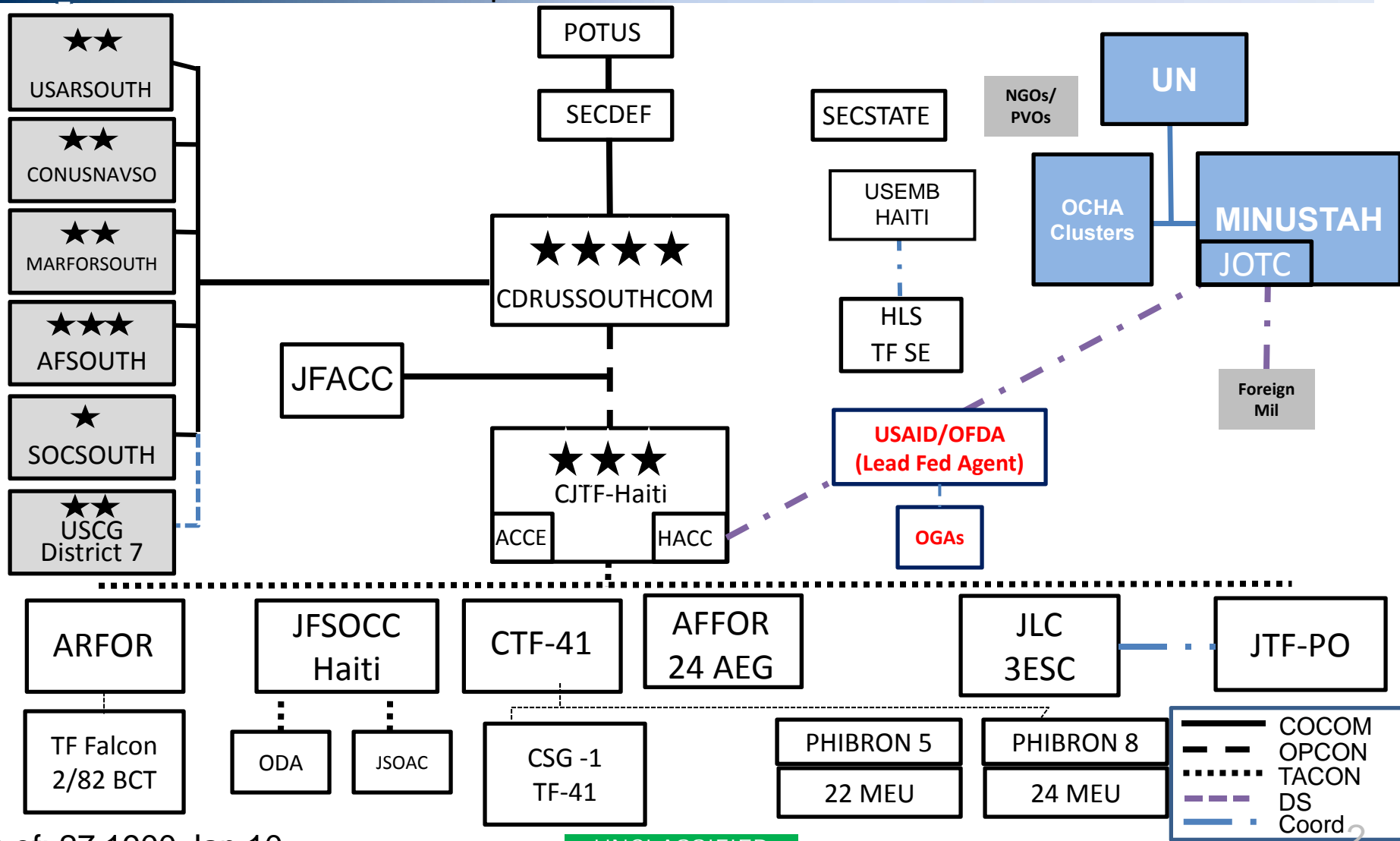



Theme and Priorities



Operation UNIFIED RESPONSE

Theme: USSOUTHCOM is working in support of USAID as a part of a global relief effort to deliver food, water, medical, and shelter assistance to the Haitian people

Today's Priority: Demonstrate delivery of food and water distribution

| USAID | USSOUTHCOM | JTF-H |
|--|--|---|
| <ul style="list-style-type: none"> • Food Distribution • Mgmt of Settlement Sites • Health/WASH (Treatment, Prevention) • Stand-up Government of Haiti (GoH) / Reconstitute-Reinforce MINUSTAH / Promote Jobs Programs | <ul style="list-style-type: none"> • Distribution • Medical • Unity of Effort • Security • Logistics Balance • Shelter | <ul style="list-style-type: none"> • Medical Capacity Restoration • Food, Water, & Shelter Distribution • Supporting Capacity Building with Partners |

JTF-H CC Assessment: US Military forces continue to arrive & expand operational capability to facilitate relief to the Haitian people. JTF-H #1 priority remains support to GOH, MINUSTAH, & USAID in distribution of HA to the Haitian people



Weather Operational Impacts



Operation UNIFIED RESPONSE

HAITI HA/DR next 12 hours

- TSTMS and low vis Jax and Pax, other areas Rain Chance $\leq 20\%$ next 5 days.
- Minor Aftershocks still occurring

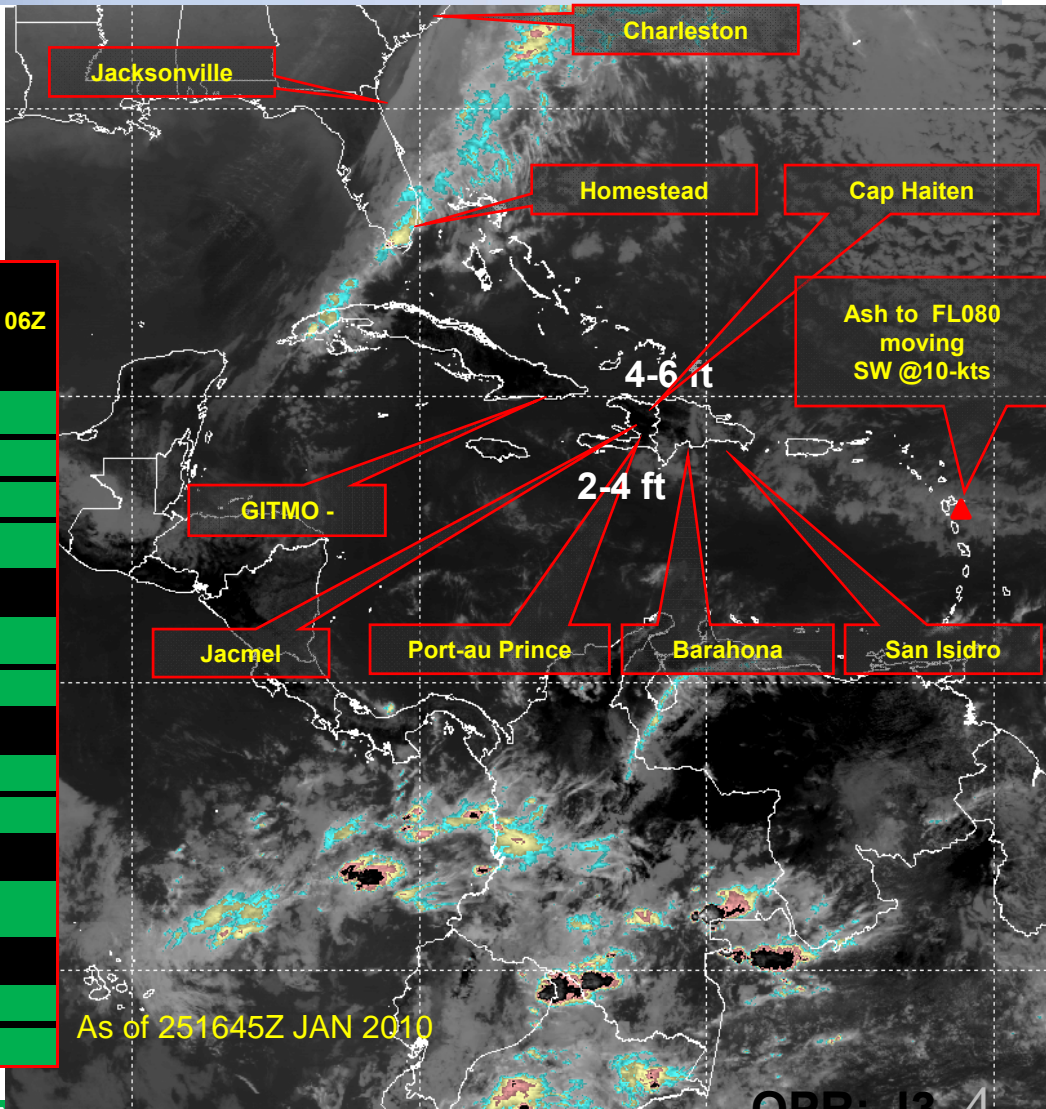

As of 251645Z JAN 2010

| | 25-Jan | | | 26-Jan | | | 27-Jan | | | | |
|--------------|--------|-----|-----|--------|-----|-----|--------|-----|-----|-----|-----|
| | 12Z | 18Z | 00Z | 06Z | 12Z | 18Z | 00Z | 12Z | 18Z | 00Z | 06Z |
| APODS | | | | | | | | | | | |
| PaP | | | | | | | | | | | |
| San Isidro | | C/P | | | | | | C | C | | |
| Barahona | | | | | | | C | C | C | | |
| Jacmel | | | | | | | | C | C | | |
| APOES | | | | | | | | | | | |
| Charleston | C | C | | C | | | | | | C | |
| Homestead | C/P | C/P | | | | | | | | | |
| SPODS | | | | | | | | | | | |
| Cap Hatien | | | | | | | C/P | C/P | | | |
| PaP | | | | | | | | | | | |
| SPOES | | | | | | | | | | | |
| Jacksonville | TS | C/P | | | | | | | | | |
| ISR | | | | | | | | | | | |
| Patuxent | TS | TS | C/P | | | | | | | | |
| PaP | | | | | | | | | | | |



RFF Tracker

Operation UNIFIED RESPONSE

- 20 RFFs Released to date, 17 RFFs SECDEF Approved
- Following pending SECDEF Approval: 6100036, 6100038, 6100039
- SDOB's pending JFP sourcing solutions

| RFF ID | Request | Status | LAD | RFF Total Est. PAX |
|---------|--|----------------------|------------|--------------------|
| 6100039 | SOUTHCOM J6 Augmentation: DHS LNO, Spectrum Managers, SATCOM Planner, Admin, Comms Planners, Net OPS Team Chief | Pending JFP sourcing | 27 Jan | 15 |
| 6100038 | JTF Haiti Enablers: Public Affairs, PSD, Construction Battalion Maintenance Unit, Financial Management Center, Expeditionary Medical Facility, Medical Logistics Management Det, Engineer Real Estate Team. | Pending JFP sourcing | 1 Feb | 884 |
| 6100036 | Worst Case Scenario-Stability Ops: (1 Med Lift Helo Bn, 1 Maneuver Enhancement Brigade, 1 MP Company, 1 Civil Affairs Co, 1 PSYOP Team. | Pending JFP sourcing | 48 hr PTDO | 3212 |



Operation UNIFIED RESPONSE



Overall Classification of this briefing is **UNCLASSIFIED**



Unity of Effort

(Interagency, International & Non-Governmental)



Operation UNIFIED RESPONSE



WFP:

- The WFP stated the Haitian Crisis is the most complex challenge they have ever confronted, however the 16 fixed food distribution sites will facilitate reaching more people and provide the capability to deliver all kinds of aid to the people of Haiti
- The 16 sites are an important step towards food stability in Haiti

DOS:

- 165 AMCITs evacuated in last 12 hours for a total of 13,928 to date/ 75 awaiting evacuation

HHS:

- Working with PAHO and USAID to conduct hospital surveillance/assessments at 12 hospitals in PaP

NGO/Business Engagement:

- GE donated 5 Mobile X-Ray units; 4 Anesthesia systems with ventilators/monitors; 10 portable ultrasound & 2 pallets of surgical/trauma/medical supplies

UN-OCHA:

- Joint Operations and Tasking Center (JOTC) developed procedures to request military/police assistance to support humanitarian relief operations
- Crowd control requirements at food distribution sites remain a concern
- Inflated prices for food and other essentials are contributing to rising tensions among the population

GoH:

- Haitian parliamentarians plan to ask President Preval to postpone upcoming elections and extend their terms by two years

Disaster Response

USAID/OFDA



Operation UNIFIED RESPONSE



Key Points (USAID Sitrep #35; UN OCHA Sitrep #15)

Settlements: GoH agreed to limit planned settlements to no more than 10,000 residents

Nutrition: Support needs for affected infants, children, lactating mothers, and pregnant women

Food: Coupons distributed for 16 WFP distro sites; Rations to be available starting 31 January

Shelter: Cluster bringing in materials to prepare for May-November rainy season

Health: Camp established on Dom Rep border to repatriate the 14,000 Haitians who left for med care

Protection: USAR teams donated tents for child spaces

GoH: USAID locating ministry operating tent sites

Logistics: Unstable crane threatening PaP port capacity

WASH: Latrine materials incoming; water distros to orphanages started

Goals to close gaps:

- Joint rapid assessment ongoing for multiple sectors
- WFP requesting mil security to fill MINUSTAH gap
- Food & shelter are GoH priorities (Montreal mtg)
- Relief orgs pushing latrine digging at settlements

• Int'l Humanitarian Community (potential) requests for DoD:

Rotary Lift, Enable Security for Food Convoys, Port Assessment & Security, Engineering, Enable Transport of Relief Supplies, Source Ready-to-Eat Meals

Countries providing support: 109 (UN OCHA/DOS)

•NGOs registered at PaP airport: 500

• USG Response: \$401 M (increase of \$3 M)



Public Affairs

Operation UNIFIED RESPONSE

Coverage: total web based articles

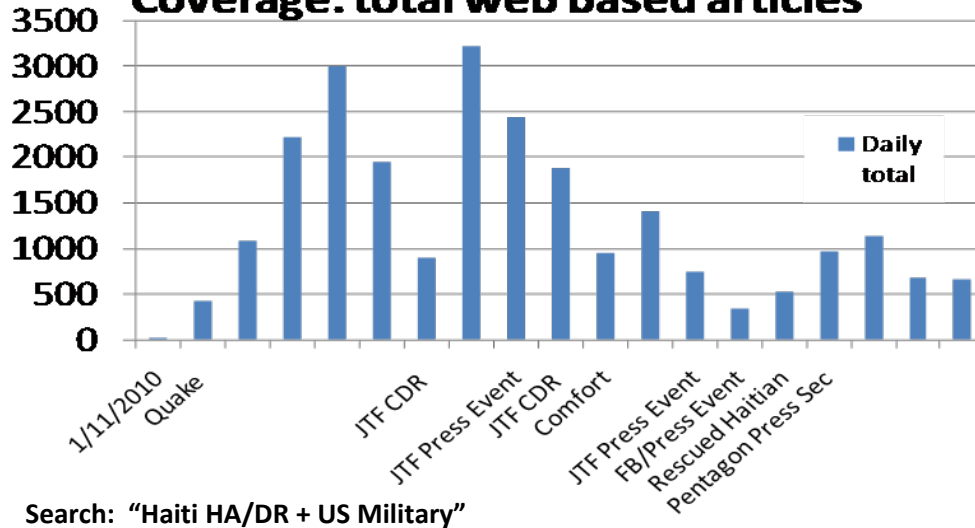

Last 24 Hours

- World Food Program Communications Plan submitted to the Joint Staff

Projected Events

- Press release on departure of USS Carl Vinson
- 2 Feb, TENTATIVE, World Food Program press conference
- 4 Feb 1000, LTG Keen Pentagon Press Corps brief

USG Themes

- Global Response to Save Lives & Ease Suffering
- Haitians helping Haitians
- Sustainability – We will stand with Haiti for the long term

Top Stories

- [U.S. suspends medical evacuations from Haiti](#) "At this moment in time, yes, the flights have stopped," said Navy Captain Kevin Aandahl, a spokesman for the U.S. Transportation Command, which manages the military's medical emergency airlifts. "We have to have a destination to bring them to," Aandahl said, citing media reports Florida had told the U.S. government that the state needed help paying for the care. (Reuters)
- Haitian police have arrested 10 U.S. citizens caught trying to take 33 children out of the earthquake-stricken country in a suspected illicit adoption scheme, authorities said Saturday. (Reuters)

Media Embeds

- USN – 21
- USAF – 1
- USA – 13
- USMC – 11



Confirmed Slot Distribution



Operation UNIFIED RESPONSE

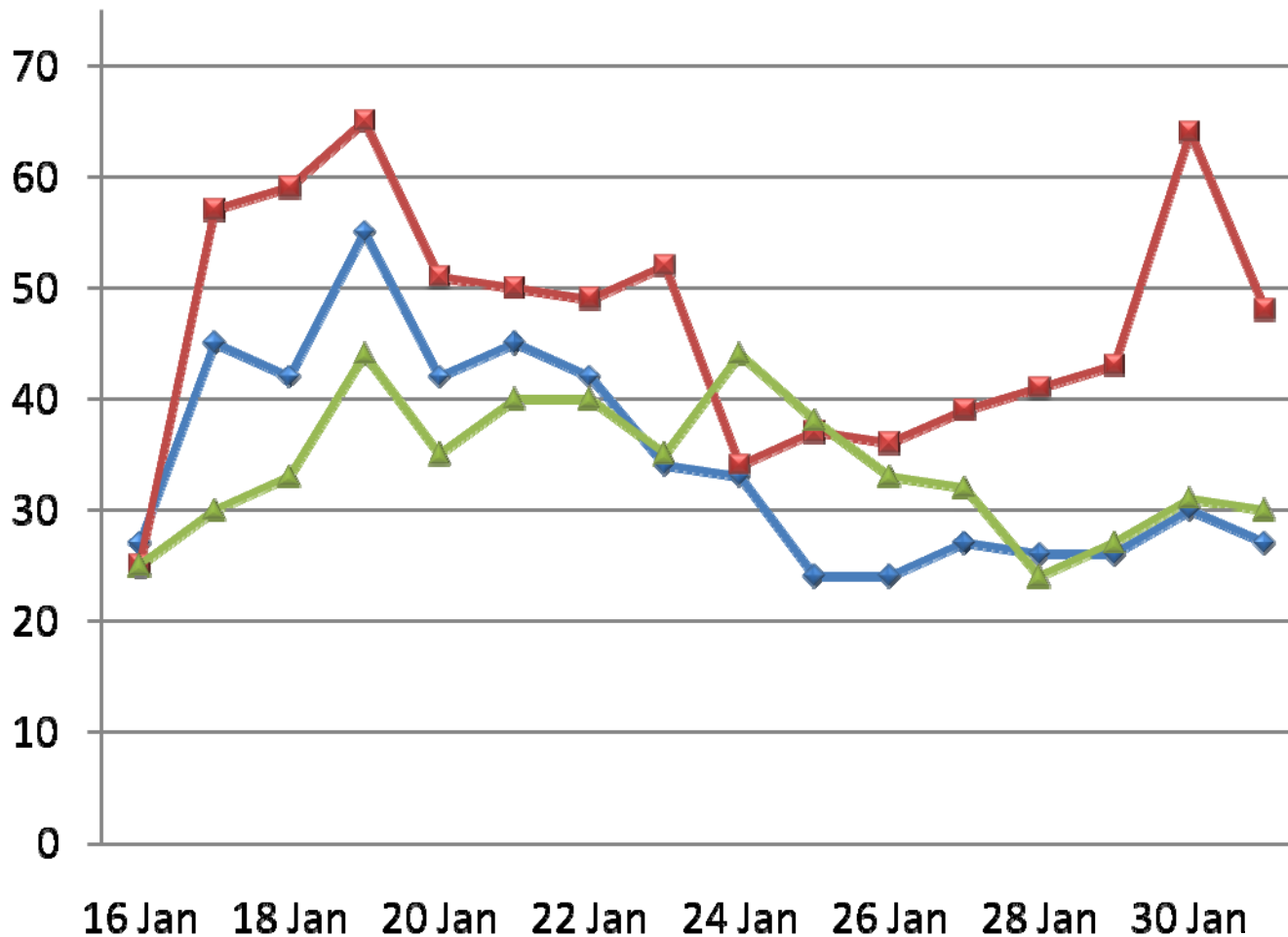

% To Date:

| | |
|---------------|------------|
| US Gov | 30% |
| US Civ | 41% |
| UN/Int | 29% |

- ◆ US Government
- US Civilian
- ▲ UN/International

Does NOT Include
changes & cancellations
Updated: 2359Z30Jan10

Slot Sortie Tracker



Operation UNIFIED RESPONSE

Confirmed Slots / Actual Sorties Into MTPP

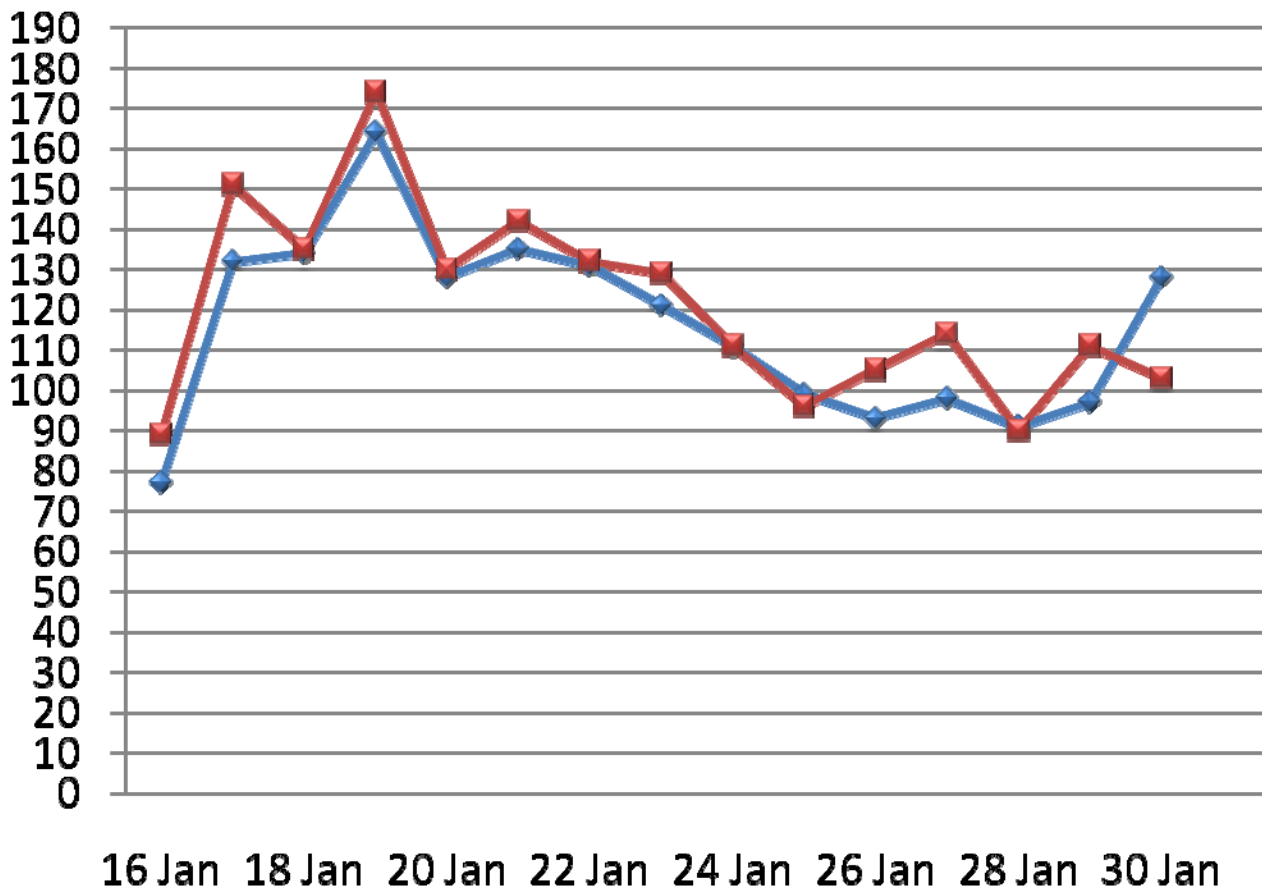

Totals to
Date:
Slots: 1741
Sorties: 1840

◆ Confirmed Slots
 ■ Actual Sorties

Updated: 2359Z30Jan10



PaP/DR SPOD/APOD

Operation UNIFIED RESPONSE

PaP APOD

Past 24 : 14/13 DoD Msn
99/90 Non DoD Msn

Current 24: 11/TBD DoD Msn
90/TBD Non DoD Msn

Next 24: 7/TBD DoD Msn
81/TBD Non DoD Msn

Barahona APOD

Past 24: 6/5 DoD Msn

Current 24: 3/TBD DoD Msn

Next 24: 1/TBD DoD Msn

San Isidro APOD

Past 24: 0/0 DoD Msn

Current 24: 4/TBD DoD Msn

Next 24: 1/TBD DoD Msn

Laffiteau SPOD

Past 24 TEU/Pcs: 56/212

Current 24 TEU/Pcs: 0/0

Next 24: American Trader

Rio de Haina SPOD

Past 24 TEU/Pcs: 0/0

Current 24 TEU/Pcs: 0/0

Next 24: N/A

PaP SPOD

Past 24 TEU/Pcs: 0/197

Current 24 TEU/Pcs: 02/70

Next 24: Williams/Heinrich

APOD Legend
Planned/Actual

SPOD Legend
TEUs/Pieces

7 Day Projection-Sea JTF HAITI Logistics Update



Operation UNIFIED RESPONSE

| ARR | VESSEL | SPOD/ Anchorage | CARGO/ PAX | Sustainment DOD | Non-Sustainment HA/DR | STATUS |
|--------|-----------------------|--------------------|-------------------|--|---|------------------|
| 30-Jan | SS Cape May | Port-au-Prince | 39 PAX | JLOTS Cargo, INLS Systems (3) (Trip 1), Floating Causeway, ROWPU (4), CESE | | Arrived |
| 30-Jan | MV Huakai | Port-au-Prince | 66 TEU 155 PAX | 689 th RPOE, 7 th SB | | Arrived |
| 30-Jan | Sea Voyager | Port-au-Prince | | | World Food Program | U/W |
| 30-Jan | SS Cornhusker | Port-au-Prince | | JLOTS Crane Ship, trucks, MHE, 1000 Exped Camp | | Arrived |
| 31-Jan | USNS Dewayne Williams | Port-au-Prince | | Fleet Hospital, Rolling Stock for 82nd AB; 1600 person base camp ; 27 pax | | ENR PaP |
| 31-Jan | MV Heinrich J | Port-au-Prince | 250 TEU | | Rice (4,500 Mtons)World Food Program | U/W |
| 31-Jan | American Trader | Laffiteau | 340 TEU | | Corn Soy Blend, veg oil World Food Program | U/W |
| 2-Feb | MV Orso | Haiti | | | | Kingston Jamaica |
| 3-Feb | Crimson Clover | Rio de Haina | 2K Tons | Meals | Meals | In Port Houston |
| 4-Feb | Crowley Maracajama | Port-au-Prince | 181 TEU | 2.4 M MRE/82nd | | ENR JAX |
| 4-Feb | Crimson Tide | Laffiteau | 138 TEU | 18 th ABN/Navy SEABEE | | ETD: 30 JAN |
| 5-Feb | Celebrity Solstice | Labadee | 65 Pallets | | Water/Medical supplies | ENR Everglades |



Communications Update



Significant Activities

DJ2 is experiencing problems receiving SIPR e-mail. The JCSE support staff is working through the technical issues to try to restore service.

- JTF GTMO**
- NIPR
 - SIPR
 - Voice
 - Comm Voice
 - VTC
 - JWICS
 - JWICS VTC
 - JVOIP
 - Predator

- SOUTHCOM**
- NIPR
 - SIPR
 - Voice
 - Comm Voice
 - VTC
 - JWICS
 - Predator
 - Global Hawk

- USS BATAAN**
- NIPR
 - SIPR
 - Voice
 - Comm Voice
 - VTC
 - JWICS
 - Predator

- 1ST SQW**
- NIPR
 - SIPR
 - Voice

- 2/82ND ABN**
- NIPR
 - SIPR
 - Voice
 - Comm Voice
 - VTC

- USS CARL VINSON**
- NIPR
 - SIPR
 - Voice
 - Comm Voice
 - VTC
 - JWICS
 - JWICS VTC
 - Predator

- 22ND MEU**
- NIPR
 - SIPR
 - Voice
 - Comm Voice
 - VTC
 - GBS

- 24TH MEU**
- NIPR
 - SIPR
 - Voice
 - Comm Voice
 - VTC
 - GBS

- JFSOCC**
- NIPR
 - SIPR
 - Voice
 - VTC
 - Comm Voice

- JTF HAITI HQ**
- SIPR
 - NIPR
 - Voice
 - Comm Voice
 - VTC
 - JWICS
 - JWICS VTC
 - JVOIP
 - PREDATOR

- US EMBASSY**
- NIPR
 - SIPR
 - Voice
 - Comm Voice
 - VTC

- MINUSTAH**
- Comm Voice
 - Predator
 - Global Hawk

- Service Active
- Service Degraded
- Service Down
- Not In Use



Future OPS Strategic Outlook



Operation UNIFIED RESPONSE

Key Upcoming Events

- ✓ WFP food surge scheduled for 31 Jan – 13 Feb 2010
- ✓ U.S. money transfer to Haiti (\$20 m) ETA 2 Feb
- ✓ CDRs SOUTHCOM and TRANSCOM visit JOA 3 Feb
- ✓ Commercial air traffic (AA) planned to resume 19 Feb

Decisions/Orders

- ★ Near Term:
 1. Transition to Ph II
 2. EMF-150 Employment
- ✓ FRAGO 014 Approved: Force Health Protection
- ✓ FRAGO 015 Approved: Country Container Authority (CCA) guidance

Strategic Focus

- ✓ Unity of Effort
 - Security and transportation support to food surge is multinational effort
 - Settlement sites limited to 10k per GoH, USAID, DART
- ✓ Flow into JOA
 - 2.7 mil MREs loading at Port of JAX, ETA JOA 4 Feb
 - 3 Mil and 7 Com vessels scheduled into JOA next 7 days
 - PaP SPOD capacity ~200 TEUs/day

- ✓ Force flow
 - USSOUTHCOM/JTF-H staffing force flow; off-ramping capabilities not required
- ✓ Strategic Communications Focus
 - WFP extending operations for 6 months ISO “essential rehabilitation measures” (DOS Sitrep)
 - Hotel Montana ops expected for 4-5 weeks



Integrated Decision Support Framework

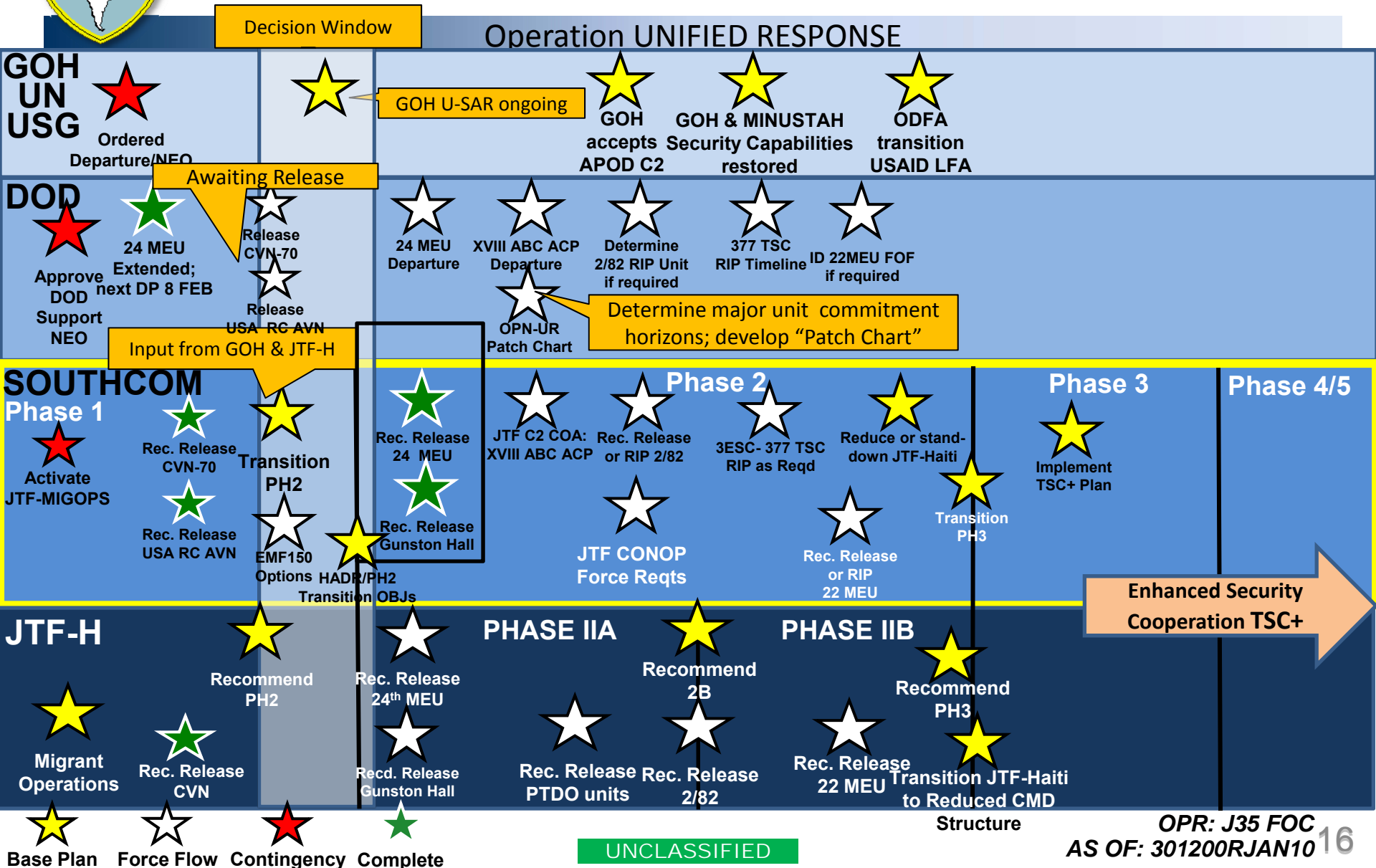



J-5 Future Plans



Operation UNIFIED RESPONSE

Last 24

- ✓ **30-Day Projection:** OPT – Received CDR’s Guidance
- ✓ **HA/DR Phase II:** OPT – Received CDR’s Guidance.
- ✓ **HA/DR Worst Case Scenario (Natural):** OPT- Continue mission analysis.
- ✓ **90-Day and 180 Day Outlook:** OPT – on-going
- ✓ **Transitioning DOD Capabilities:** OPT – on-going
- ✓ **Overall Campaign Plan:** OPT – on-going

Next 24

- ✓ **30-Day Projection:** OPT – on-going.
- ✓ **HA/DR Phase II:** OPT – on-going. Refine analysis. BPT brief CDR.
- ✓ **HA/DR Worst Case Scenario (Natural):** OPT – on-going.
- ✓ **90-Day and 180 Day Outlook:** OPT – on-going
- ✓ **Transitioning DOD Capabilities:** OPT – on-going
- ✓ **Overall Campaign Plan:** OPT – on-going

Support Required

- ✓ **Continued augmentation**

Challenges

- ✓ **None**



CCGDSEVEN



Operation Unified Response

- CGC OAK / LANT MTSRU / PSU 307 supporting CTF-42 PAP port ops & security
- CTU 44.7.7 (5 USCG cutters) providing persistent presence along Haitian coastline
- Fixed & rotary wing supporting coverage for migrant I&W & USCG logistics

*CG Personnel deployed in Haiti ISO CTF-42: **180**

Future Ops

- Maintain current force laydown & ops
- Inspect & repair Cap Haitien HCG boats

Issues/Decisions

- Alignment between humanitarian aid providers, shipping community & Haitian port facilities to maximize delivery of commodities
- Support flow of basic foodstuffs & essential goods to outlying ports to ensure security in the Haitian countryside



NAVSOUTH



Operation UNIFIED RESPONSE

LINES OF OPERATION

FUTURE OPS

ISSUES/DECISIONS



ARSOUTH



Operation UNIFIED RESPONSE

LINES OF OPERATION

- Operation Unified Response:
 - Planning / Preparation for employment of C2 element
 - Safety Officer arrived at Homestead; Departs for Haiti 311400Jan
 - ARSOUTH deployed 72 PAX as of 30 Jan
(Haiti – 43; GTMO – 21; Other – 8)
- Theater Engagements:
 - MEDRETE Execution in Colombia and El Salvador (11 Jan – 6 FEB)
 - Colombia mission support for ARL- Apiay, and FOPEN- Bogota

FUTURE OPS

- Deployment of Medical Augmentees to SC ISO JTF-Haiti, 1 Feb
- Working STAMIS and LOGCAP with JTF-Haiti
- GTMO Assessment on-going

ISSUES / DECISIONS

- Reporting Channels

JTF MIGOPS Update

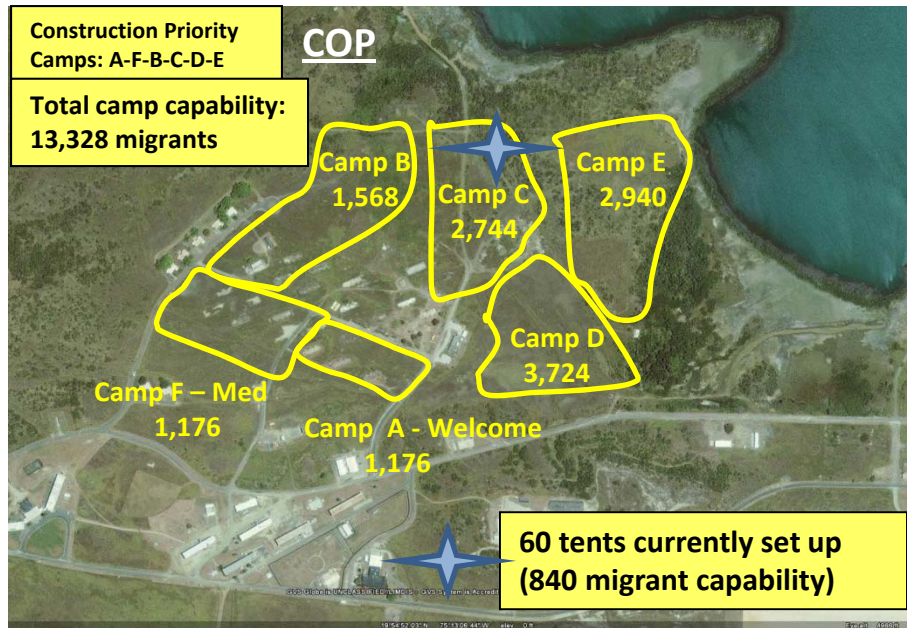

Actions to Date

- JTF requested RFF - 17 Jan 2010
- Assessment Team on GTMO
- Established liaison with DHS; NAVSTA GTMO; JTF GTMO
- Equip O/H: 860 tents; 20k cots
 - 340 tents/5k cots supplied to JTF Haiti
- C2 equipment in place: DJC2/SC2IP/RRK/SC TACSAT/Trojan Lite and prime movers

Engineer Assessment Status

- Current capability to 7k migrants
- Preparation is required to achieve 13k migrants
- Engineer assessment ongoing

Issues/Discussions

Operational Readiness

- No scheduled airflow
- PTDO required for 5K+ migrants
- O/H forces can only support 2k migrants

Facility Readiness

- O/H forces: 3 days for 2K; 7 days for 5K
- \$2,309K required to support 5K migrants
- Additional cost analysis ongoing

Sustainment Readiness

- Four DOS for 5K migrants
- Kitchen sets require 45 day lead time
- \$2,150K required to support 5K migrants
- Additional cost analysis ongoing

MARFORSOUTH



Operation UNIFIED RESPONSE

Current Ops

Future Ops

Issues/Decisions



SOC SOUTH



Operation UNIFIED RESPONSE

Current Ops

- 5 x ground assessment teams continue Day #5 of reconnaissance and assessments north of latitude 18°45' to answer JTF-HAITI priority intelligence requirements; adjusting teams' employment in assigned zones in order to further refine the JTF Commander's PIR
- JFSOCC elements conducted an assessment of the Baptist Mission Clinic in Fermanche, in accordance with JTF-H FRAGO 044
- Received 9,100 radios and coordinating distribution with JTF units, USAID and NGOs
- CMSE completed transition with JTF CA Units and relocating to JFSOCC-FWD HQ

Future Ops

- Continue reconnaissance mission in zone to answer COMJTF priority information requirements; develop COAs for areas of detailed civil reconnaissance.
- Mission Analysis for JTF-FRAGGO 45
- Delivery of 13,900 self-powered radios from manufacturer by 4 FEB 10

Issues/Decisions



AFSOUTH



Operation UNIFIED RESPONSE

Current Ops Total

- Total airlift sorties into Hispaniola: 1,997
 - DoD sorties: 472
 - DoD Contract sorties: 25
 - Non-DoD sorties: 1,500
- Total short tons delivered: 11,516
- Pax delivered: 7,470
- AMCITs evacuated to date: 13,828

STons Delivered & 1-day Forecast

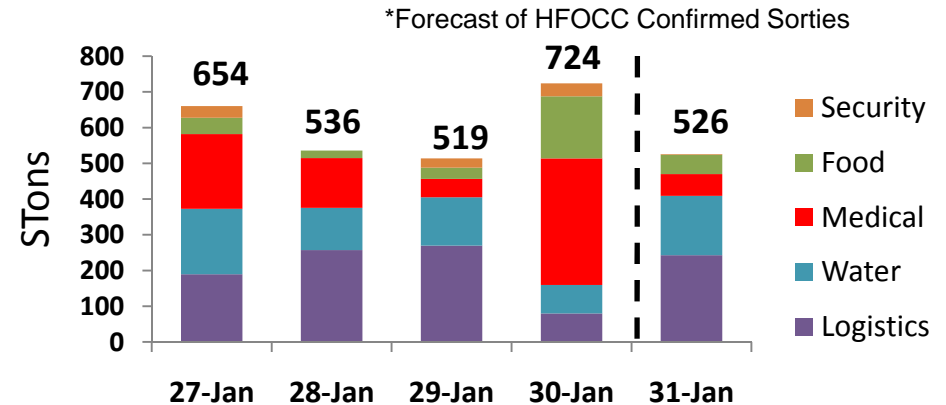

Future Ops (Next 24 hrs)

- PaP Arrivals: 102 for 31 Jan
- ISR:
 - 3 x P-3, 2 x RC-26, 2 x RQ-1, 1 x U-2
- AEW:
 - 4 x E-2
- DoD Inter & Intra-theater airlift:
 - 7 x C-17, 3 x C-130, 15 x other, 0 x charter

Issues/Decisions

- Scheduled commercial aircraft to resume at MTPP
 - ~19 Feb
 - 3 aircraft per day
- TPN-19 – PTDO in CONUS



AFSOUTH



Operation UNIFIED RESPONSE

Port-au-Prince Flow Control by Category

Next 24 Hrs

| <u>Category</u> | <u># Missions</u> | <u>Estimated STONS</u> | <u>% of Effort by STONS</u> |
|-------------------------|-------------------|------------------------|-----------------------------|
| Trans / Logistical Supt | 33 | 243 | 42% |
| Water / Relief Supplies | 36 | 166 | 29% |
| Medical | 24 | 61 | 11% |
| Food | 7 | 54 | 9% |
| Security | 2 | 2 | <u>0.3%</u> |

MTPP Total: 91%

Additional APODs

| | | | |
|---------------------|---|----|-----------|
| Maria Montez (MDBH) | 3 | 21 | 4% |
| San Isidro (MDSI) | 4 | 28 | 5% |
| Jacmel (MTJA) | 0 | 0 | <u>0%</u> |

Other APOD Total: 9%



JIATF - SOUTH



Operation UNIFIED RESPONSE

- Standing CD ops in CARIB:
 - 67% CD surface assets in support of Haiti HA/DR and potential OVS
 - 30% CD air assets in support of Haiti HA/DR
- Standing CD Ops in EPAC
 - 25% surface assets in support of Haiti HA/DR and potential OVS

Future Ops

- Monitoring I&W for potential DTO exploitation

Support Available

- Logistics assistance to SC staff
- Imagery analysis support
- Facilitation by International LNOs



JTF-GTMO



Operation UNIFIED RESPONSE

Current Ops

Future Ops

Issues/Decisions

As of:



JTF-BRAVO



Operation UNIFIED RESPONSE

Current Ops

- MEDEL(-)
 - 23 personnel, equipment and supplies located at Coast Guard Station Killick
 - Since 19JAN10, MEDEL(-) **total** includes:
 - Triage/treated 1,628 patients
 - Performed 34 surgeries
 - MEDEVAC'd 391 patients
 - Place 60 in MEDHOLD
 - Continue to coordinate for logistical and medical support requirements with JTF-Haiti J4
 - Killick team now includes medical personnel from Haiti, Sri Lanka, Mexico, Colombia

Future Ops

- Standing by for additional JTF-B support to Haiti (Aviation, C2, Security as required)
- 612th ABS – expecting movement of 3 fire trucks and 1 tanker truck in support of JTF-Haiti – No impact to JTF-B mission
 - Expect airflow on 3FEB10(T)

Issues/Decisions

- NSTR



USCG LANT AREA Current Ops



Operation UNIFIED RESPONSE

Current Key Operations

- MTSRU is monitoring a bulk petroleum offload at Thor facility, expected to finish 31JAN.
- MTSRU completed assessment on Jacmel port; pier height 10ft; water depth 20ft.
- Haitian Garde Cote (HGC) status: Daily food, water, and fuel needs of HGC are being met.

Future Key Events

- Rotate engaged cutters to GITMO for re-supply
- NCAGS/MTSRU will cross-deck from the CGC Oak to the SS CORNHUSKER STATE on 31 Jan 2010 and continue to maintain VTM.

Key Leader Engagement

Port Management daily meetings:

- APN, USAID, TRANSCOM, SOUTHCOM, MIFC
- Coordinate HSTF-S operations in the JOA



Operation UNIFIED RESPONSE

Commander's Concerns and Guidance